



An Improved Method For Measuring Losses In Short Waveguide Lengths

ONE OF the difficult and recurring measurements in microwave work is measuring the losses in short lengths of waveguide — losses which are typically a fraction of a db. The literature describes several methods for making such measurements, but in general these have suffered from one of two significant disadvantages: either they involved extremely precise mechanical equipment and techniques or they depended for their result on taking the difference between two measurements of nearly equal quantities. Where such differences must be taken to obtain the desired answer, a small error in one or both of the measurements results in a large error in the answer.

SEE ALSO:
How doppler shift gives satellite data
p. 5

A new method has been devised for measuring waveguide losses as small as 0.02 db — losses equal to those introduced by only 3 to 6 inches of X-band brass guide. The method is free of the previously-mentioned disadvantages, can be used with rectangular, ridged,

and other types of guide, and is accurate within approximately 10%. In addition, determination can be made as to whether losses are distributed or local. Further, an adaptation of the method enables losses to be examined on a rapid swept basis to facilitate production work. The method covers the whole small-loss region, since it can be used to measure losses up to 2 db or so where measurements by established substitution methods become practical.

MEASUREMENT TECHNIQUE

In the new method loss is determined by clamping the waveguide sample to be investigated between two irises of previously-established transmission and measuring the transmission of the iris-coupled resonant cavity thus formed with the setup shown in Fig. 1. The transformations that occur in the resonant system are such that the waveguide loss, although it is small, strongly influences the transmission of the cavity. When the transmission of the cavity and the transmission of the individual irises have been determined, the loss

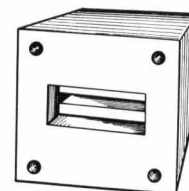
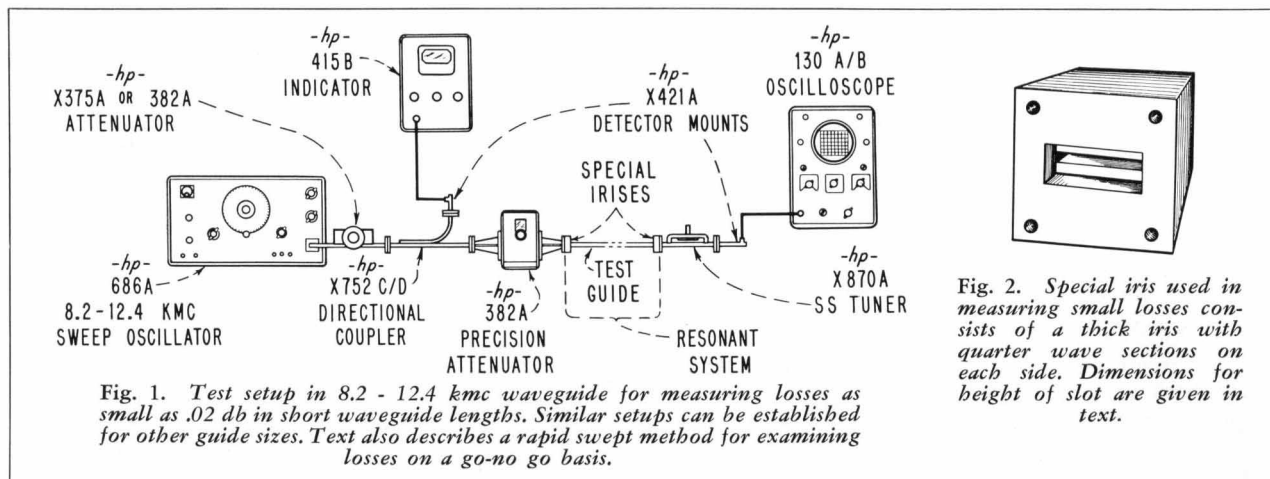

Fig. 2. Special iris used in measuring small losses consists of a thick iris with quarter wave sections on each side. Dimensions for height of slot are given in text.

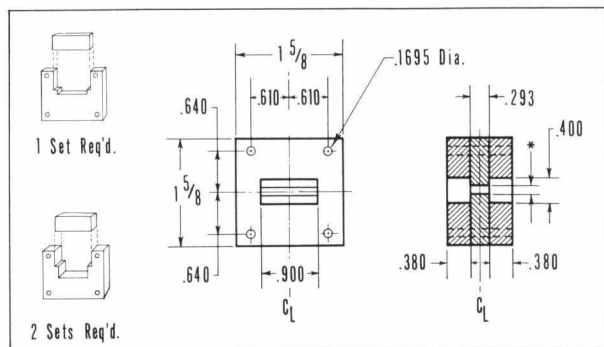

Fig. 3. Dimensions of irises used for 8.2 - 12.4 kmc guide. Slot heights (marked *) depend on attenuation range to be measured as described in text. Iris dimensions can be directly scaled for other guide sizes. Sketch at left suggests fabrication method. All joints should be carefully soldered and the completed assembly silver-plated.

in the waveguide sample can be readily calculated as shown in the accompanying derivation (p. 3).

The overall process consists of three steps. The first is to construct the irises and measure their transmission. Normally, this need only be done once for a given size of guide and range of loss to be measured, since the irises can then always be used for subsequent measurements. The second step is to measure the transmission of the cavity, while the final step is to calculate the guide loss from the measured iris and cavity transmission values.

IRIS DESIGN

Several types of irises including the simplest case of a circular aperture in a thin metallic diaphragm have been investigated for suitability for these measurements. The most satisfactory has been found to be a horizontal slot in a wall that is one-quarter wavelength thick at a frequency near the top of the band covered. Such an iris (Fig. 2) is relatively easy to construct and has a transmission characteristic that is favorable for this type of measurement, i.e., the transmission decreases with frequency to compensate for the typical decrease with frequency in the loss of a waveguide. A set of three pairs of such irises will cover the 0.02-2 db range as described below.

Several considerations enter into the design and fabrication of the

MEASUREMENT RANGE PERMITTED BY IRIS	IRIS SLOT HEIGHT	RANGE OF INSERTION LOSS OF RESULTING CAVITY
0.1 - 0.02 db	0.0120"	15 - 6.5 db
0.4 - 0.1 db	0.0242"	15 - 6.5 db
2.0 - 0.4 db	0.0547"	15 - 6.5 db

irises. The first of these is that the combination of iris transmission together with loss in the waveguide sample must be such that a signal of usable magnitude is received by the de-

efficient should not be less than about 2% for the smallest losses to be measured (0.02 db) nor more than about 30% for losses of 2 db. The table above suggests iris slot heights for various ranges of attenuation to be measured in 1" x 1/2" guide. These heights can be directly scaled to any other guide size for the same ranges of attenuation.

detector in the setup of Fig. 1. These factors have been investigated for 1" x 1/2" brass waveguide and it has been found for the setup of Fig. 1 that the iris voltage transmission co-

The measurement ranges shown are nominal and an overlap of 50% or so is normally available when these irises are used with the setup of Fig. 1.

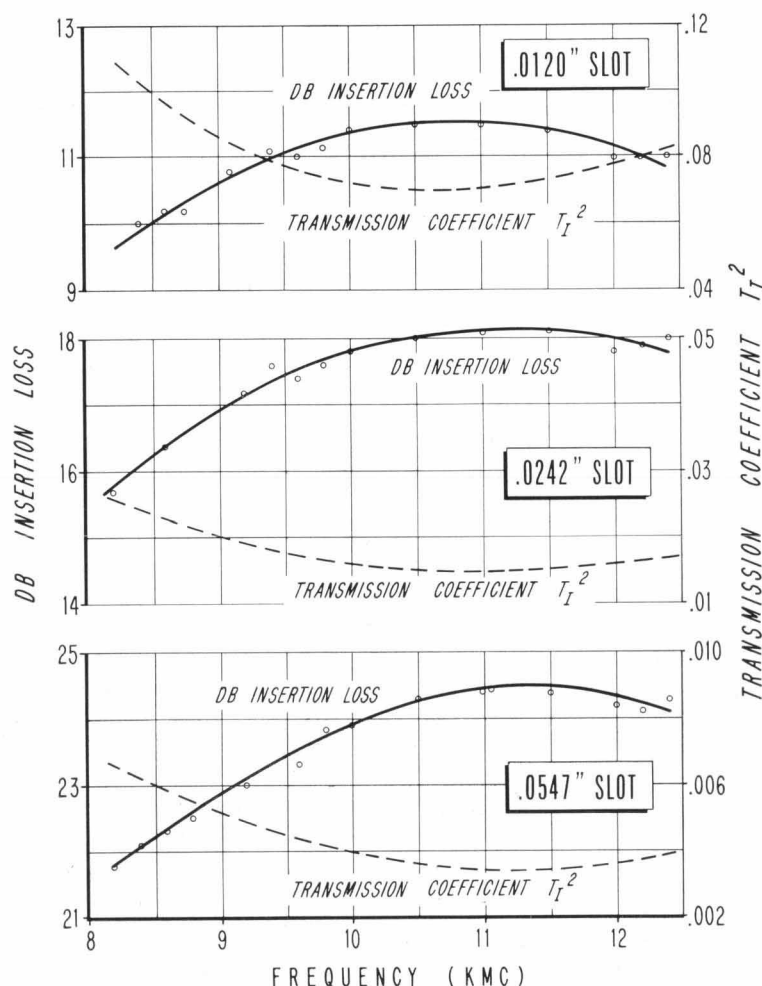

Fig. 4. Measured transmission coefficients of three irises for .02 - 2 db loss range. Similar data should be measured for irises used.

A second consideration involves the physical arrangement of the iris. Since the iris will be a low-impedance point in the guide, a high current will flow across it. Nominal quarter-wave sections should thus be soldered on each side of the iris to minimize losses at the iris-to-guide connection. Sections 0.380"

long will be a quarter-wavelength at mid-band.

The third consideration in the iris design is that the transmission of the two irises must be identical. This is mentioned only passingly, however, since no measurable difference in transmission has been encountered in any irises constructed.

A detail drawing of the final iris is shown in Fig. 3. This can be scaled directly for other guide sizes.

IRIS TRANSMISSION MEASUREMENT

The transmission of each iris should be separately measured with the setup of Fig. 1 by inserting a

(Cont'd next page)

For purposes of analysis the measuring arrangement of Fig. 1 in the accompanying article can be reduced to the equivalent circuit shown below.

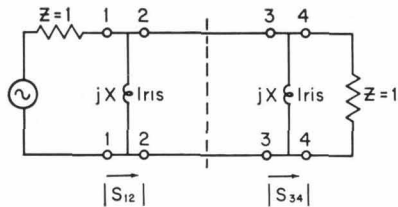

Fig. 1. Equivalent circuit of test setup used for measuring small waveguide losses.

An analysis will show that the scattering coefficients of an iris in a line followed by a termination (Fig. 2) are*

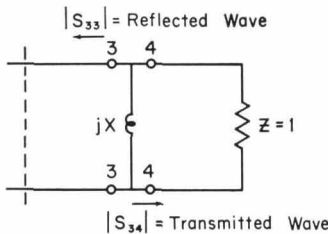

Fig. 2. Right half of equivalent network of test setup.

$$|S_{33}| = \frac{1}{(1 + 4X^2)^{1/2}} \quad (1)$$

for the reflected wave and

$$|S_{34}| = \frac{2X}{(1 + 4X^2)^{1/2}} \quad (2)$$

for the transmitted wave

Normalized wave amplitudes are then as shown in Fig. 3.

*This is obtained as follows: the equivalent series impedance of the iris and load (Fig. 2) is:

$$Z_l = \frac{jX}{1 + jX}$$

The reflection coefficient of the iris and load is

$$\rho = \frac{Z_l - 1}{Z_l + 1} = \frac{-1}{1 + 2jX}$$

Therefore the scattering coefficient of the iris and load has a magnitude

DERIVATION OF WAVEGUIDE SMALL-LOSS EQUATION

When the cavity is excited by a frequency that makes it resonant, there can be either a voltage maximum or a minimum at the center, depending on whether

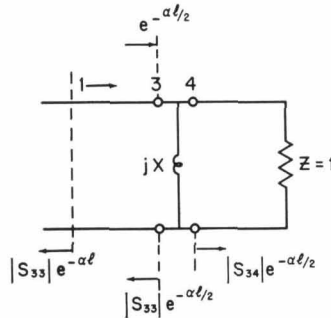

Fig. 3. Wave amplitudes defined for right half of network.

the cavity is an odd or even number of wavelengths. The voltage amplitude at the center will then be

$$1 \pm |S_{33}| e^{-\alpha l}$$

and the current will be

$$1 \mp |S_{33}| e^{-\alpha l}$$

The power flow across the center line is the product of voltage and current.

$$P_{CL} = 1 - |S_{33}|^2 e^{-2\alpha l} \quad (3)$$

The power received by the load is

$$|S_{33}| = |\rho| = \frac{1}{(1 + 4X^2)^{1/2}}$$

Since power transmitted by the iris is the difference between power incident on the iris and power reflected by the iris, and since transmitted power is the square of transmitted voltage,

$$|S_{34}|^2 = 1 - |S_{33}|^2 = 1 - \frac{1}{1 + 4X^2}$$

Therefore,

$$|S_{34}| = \frac{2X}{(1 + 4X^2)^{1/2}}$$

$$|S_{34}|^2 e^{-\alpha l} \quad (4)$$

The efficiency of the network in Fig. 3 is (4) ÷ (3) or

$$\eta_{1/2} = \frac{|S_{34}|^2 e^{-\alpha l}}{1 - |S_{33}|^2 e^{-2\alpha l}} \quad (5)$$

Since the network of Fig. 3 represents one-half of a symmetrical system, the overall efficiency will be the square of (5) or (5) gives directly the overall voltage transfer coefficient:

$$T_c = \frac{|S_{34}|^2 e^{-\alpha l}}{1 - |S_{33}|^2 e^{-2\alpha l}} \quad (6)$$

This (6) is the voltage transmission coefficient of the waveguide sample when formed into a resonant iris-coupled cavity.

If (1) and (2) are now substituted into (6) and (6) solved for $e^{-\alpha l}$, the result is

$$e^{-\alpha l} = \left(1 + 4X^2 + 4 \frac{X^2}{T_c^2}\right)^{1/2} - \frac{2X^2}{T_c} \quad (7)$$

If the iris transmission coefficient (2) is now solved for X,

$$X = \frac{|S_{34}|}{2} \cdot \frac{1}{(1 - |S_{34}|^2)^{1/2}} \quad (8)$$

Since $|S_{34}|$ is the voltage transmission T_i of an iris, (8) can be restated:

$$X = \frac{T_i}{2} \cdot \frac{1}{(1 - T_i^2)^{1/2}} \quad (9)$$

Thus, by measuring the transmission of an iris, X can be found.

Finally, substituting (9) into (7) gives for the wave $e^{-\alpha l}$.

$$e^{-\alpha l} = \left[1 + \frac{T_i^2}{1 - T_i^2} \left(1 + \frac{1}{T_c^2}\right)\right]^{1/2} - \frac{T_i^2}{2T_c(1 - T_i^2)} \quad (10)$$

When T_i is less than 0.05 and l is small, the loss is approximated by

$$\text{db LOSS} = 4.34 T_i^2 \left(\frac{1}{T_c} - 1\right) \quad (11)$$

T_i and T_c can be measured as described in the accompanying article. Therefore, the loss in the waveguide sample can be computed from (10) or (11).

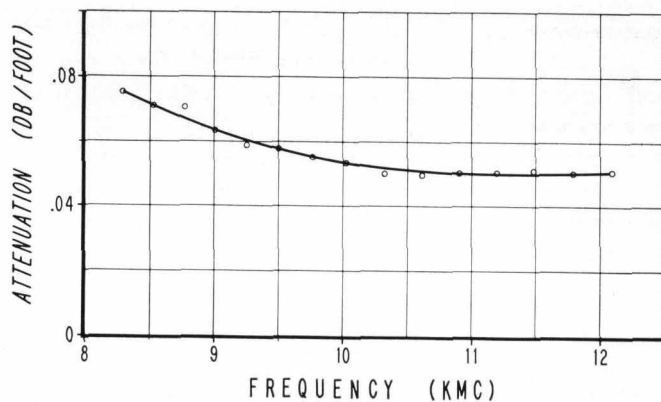

Fig. 5. Attenuation of 15½ inch section of 8.2 - 12.4 kmc brass waveguide measured using method described herein.

single iris in place of the cavity. The technique is to note the difference in attenuation needed with the Model 382A precision attenuator when the iris is in and out of the system to obtain a constant level at the detector. Care should be taken to insure that the slide-screw tuner is properly tuned and that the power level at the output of the left-hand attenuator is constant for both measurements. When such measurements have been taken at a number of frequencies, curves like those in Fig. 4 should be obtained. As mentioned above, no difference in the transmission characteristics of a pair of irises is normally encountered.

CAVITY TRANSMISSION MEASUREMENT

When irises of accurately-known transmission are at hand, the loss in the guide section under investigation can be determined by making transmission measurements of the resonant cavity at a number of frequencies with the test arrangement indicated in Fig. 1. Since the measurements must be made at frequencies where the cavity is resonant, care must be taken to insure that the slide-screw tuner does not obscure resonance. Care must also be taken to insure that the detector is always operated at the same level. The following procedure is suggested for the measurements.

The first step is to adjust the oscillator to a cavity resonance near a frequency of interest without allowing tuner mismatch to affect the response. To accomplish this, the tuner

should be removed and the oscillator frequency adjusted in the desired region for a resonance as indicated by a peaked output on the oscilloscope. After the oscillator frequency has been set, the resonant cavity (guide test piece and irises) should be removed from the system and the slide-screw tuner inserted and adjusted to maximize detector output.* At the same time the level applied to the detector mount should be adjusted to the value to be used in the measurements. A level such that a detector output of 10-15 millivolts is applied to the oscilloscope is recommended. Such a level is easily measured with the Model 130A/B oscilloscope.

The second step is to measure the transmission of the resonant system. This is done by re-inserting the cavity into the measurement system, adjusting the oscillator so that it now sweeps around the resonant frequency ($\Delta f = 44$ mc is suggested), and adjusting the power level applied to the cavity so that the peak of the resonance curve now displayed on the oscilloscope is at 15 millivolts

*When highest accuracy is required, the tuner should be adjusted with a slotted line so that the load VSWR is less than about 1.04.

Fig. 6. Typical oscilloscope presentation obtained when sweeping resonant system formed by guide test piece and irises. Each peak is a cavity resonance. By establishing response envelope of a test piece of minimum acceptable performance, such a swept display can be used for rapid go-no go production checks. Rough quantitative data can also be obtained.

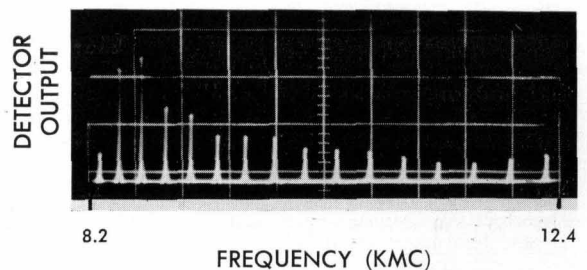

or at the level established in the step above. It is important in this step that the level be adjusted with the attenuator at the output of the oscillator and that the precision attenuator be set for zero attenuation. Note should also be taken of the power incident on the precision attenuator.

When the peak transmission has been set in this manner, the resonant cavity should be removed and the Model 382A precision attenuator adjusted until the same detector output level is obtained on the oscilloscope as with the cavity in the system. Typically, the attenuator will now be set for a value between 5 and 20 db as determined by the loss measured. The power incident on the precision attenuator should, of course, be the same as that incident on the cavity in the step above as determined by the first power monitor. The reading of the precision attenuator is the transmission of the resonant cavity and can be substituted in coefficient form into equation (10) or (11) in the accompanying derivation to obtain the loss of the waveguide section.

The procedure can be repeated for as many frequencies as desired. Fig. 5 shows results obtained with this procedure for a 15½ inch length of 1" x ½" brass guide.

LOCAL LOSSES

If a local loss exists in the guide sample under measurement, it will usually be frequency-sensitive and will thus usually cause an irregularity in the loss vs. frequency curve. Such a loss can therefore be identified if measurements have been made at a number of frequencies.

(Concluded on p. 6)

HOW DOPPLER SHIFT RECORDS PROVIDE SATELLITE RANGE AND HEIGHT DATA

The *Supplement* included with the last issue of the *Hewlett-Packard Journal* showed a doppler-shift record made by the Stanford Research Institute of the 40-megacycle transmission from Sputnik I on one of that satellite's passes. Such records were made using the -hp- counter-digital recorder arrangement described in the *Supplement* to investigate the satellite's orbit. This arrangement has proved to be a powerful method for obtaining initial range and height information about transmitter-carrying satellites. In the first place, it normally enables data to be gathered when weather conditions or time of day defeat optical methods and yet it does not involve complicated directional equipment. Further, the equipment arrangement is relatively simple and is itself capable of recording the received frequency to very high resolution and accuracy, although in the case of the 20- and 40-megacycle frequencies of Sputnik's transmitters the received doppler record is influenced by atmospheric propagation effects. These effects impose a natural limitation on the ac-

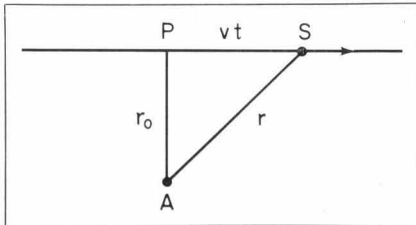

Fig. 1. Diagrammatic representation of linearly-moving transmitter passing a fixed receiving station.

curacy of initial extractable information, which, in the case of Sputnik's 40-megacycle transmitter, has been estimated at SRI to be in the order of 2 to 3 per cent in range. For the 108-mc transmitters planned for U.S. satellites, however, propagation effects are much less pronounced and the accuracy can thus be several times better, provided sufficient signal-to-noise ratio can be maintained. Further, if simultaneous doppler records are made at three or more appropriately-located stations, a substantial amount of orbital information can be gained from a single pass. In summary, the doppler system appears to be a valuable supplement to the minitrack system first proposed. In addition, simultaneous doppler records of the different transmitter frequencies of a satellite can yield valuable propagation information.

To demonstrate how range and height information can be obtained from a doppler shift record, consider first the simple case of a transmitter S moving at uniform velocity v in a straight line path past a receiving antenna A, as shown in Fig. 1. If we take $t = 0$ at the instant of closest

approach, then the slant range, r , as a function of time is

$$r(t) = \sqrt{r_0^2 + v^2 t^2} \quad (1)$$

where r_0 is the *minimum slant range*. By successive differentiation with respect to time, we find the range rate,

$$\dot{r}(t) = \frac{v^2 t}{r(t)} \quad (2)$$

and the range acceleration

$$\ddot{r}(t) = \frac{v^2 - \dot{r}^2(t)}{r(t)} \quad (3)$$

At closest approach, $t = 0$, and these three quantities have the values

$$r(0) = r_0 \quad (1a)$$

$$\dot{r}(0) = 0 \quad (2a)$$

$$\ddot{r}(0) = \frac{v^2}{r_0} \quad (3a)$$

RANGE INFORMATION

The received frequency f will be given by

$$f(t) = f_0 \left(1 - \frac{\dot{r}(t)}{c}\right) = f_0 - \frac{\dot{r}(t)}{\lambda} \quad (4)$$

where

$$f_0 = \text{transmitter frequency}$$

$$c = \text{velocity of light}$$

$$\lambda = \frac{c}{f_0} = \text{wavelength}$$

Differentiating (4) gives

$$\frac{df}{dt} = -\frac{\ddot{r}(t)}{\lambda} \quad (5)$$

The maximum value of \ddot{r} occurs at $t = 0$, so

$$\frac{df}{dt}_{\text{MAX}} = -\frac{v^2}{\lambda r_0}$$

or

$$r_0 = \frac{v^2}{\lambda \left(-\frac{df}{dt}\right)_{\text{MAX}}} \quad (6)$$

Equation (6) enables the minimum slant range to be found if the velocity v is known. Velocity can be determined in several ways as discussed below.

VELOCITY INFORMATION

One method of determining velocity is from a doppler shift record that shows the full shift. At distances large compared with r_0 , the range rate approaches the velocity, i.e.,

ABOUT SPUTNIK II —

The tracking programs established for investigating the orbit of Sputnik I clearly showed that doppler shift analysis was a principal method for gathering information about newly-launched satellites. As a result, considerably wider use was made of the -hp- counter-digital recorder combination described in the Supplement to the last issue to obtain information when Sputnik II was launched. The equipment was also put to expanded use in this respect by the Stanford Research Institute of Menlo Park, California whose engineering staff made the record reproduced in the Supplement. Immediately following the announcement of the launching of Sputnik II, SRI instigated a combination Institute sponsored-contract supported* program to obtain information about that satellite. -hp- cooperated with SRI by providing equipment for use in the expanded SRI program at Montana State College Research Foundation, Bozeman and the Geophysical Institute of the University of Alaska, Fairbanks. The information obtained by these two facilities was to be correlated with that obtained by the Menlo Park facility to gain more accurate information about orbital paths as well as propagation information and to permit observations to be made of Sputnik II using the SRI 400-megacycle Alaska radar.* Unfortunately the short life of the Sputnik II transmitter permitted the collection of data only on a limited basis, although the equipment is now standing by ready for future observations.

*Contract AF 30(602)-1762 with Rome Air Development Center.

$$\dot{r}(-\infty) = -v$$

$$\dot{r}(\infty) = v$$

Thus the total doppler shift, Δf , (see Fig. 2) is

$$\Delta f = f(-\infty) - f(\infty) = \frac{2v}{\lambda}$$

and velocity is

$$v = \lambda \frac{\Delta f}{2} \quad (7)$$

If a complete doppler shift record is not available (owing to loss of signal at extreme range, for example), the velocity may be found by drawing as near as possible to each end of the available doppler-shift record a tangent to the curve. These two tangents should be of equal slope

(Concluded on next page)

Fig. 2. Since the mathematical form of a doppler shift curve is known, one method of obtaining initial velocity data consists of drawing tangents near ends of available part of partial doppler record and forming ratio as described in article.

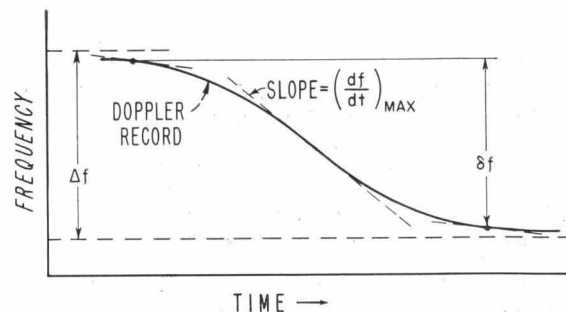

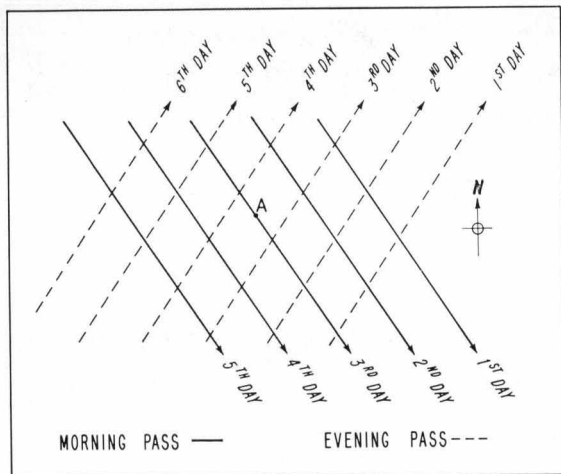

Fig. 3. Sketch of day-by-day precession of satellite track past a receiving station A.

(Fig. 2). If S is its slope, and if

$$\eta = \frac{\left(\frac{df}{dt}\right)_{\text{MAX}}}{S}$$

it is easily shown that for a straight-line pass

$$\Delta f = \delta f \frac{\eta^{1/3}}{\sqrt{\eta^{2/3} - 1}}$$

where δf is the frequency shift between the points of tangency.

Since these methods assume a straight-line pass, they have greatest value as a first method to obtain information quickly or when the approach is relatively close.

VELOCITY FROM HEIGHT INFORMATION

The velocity of a satellite can also be determined, of course, if the satellite's period and height are known. Often only the period is known so that it is necessary to find the height. In this case an approxi-

mate height may be assumed and the velocity thus obtained used to determine a more accurate height by the procedure outlined below. This more accurate height is then used to recompute velocity and the calculations repeated. Convergence will be quite rapid as long as the height is small compared with the earth's radius.

ORBITAL RANGING

So far we have considered only the case of a straight-line pass past a fixed station in order to demonstrate the principles involved. Although this case can be and has been used to extract meaningful data, in practice the exact solutions become more complicated since the transmitter is moving in an elliptical orbit and the receiver is being carried through the plane of the orbit by the earth's rotation. It may be of interest, however, to consider a rather simple procedure whereby the height information contained in the

slant range data can be obtained to a somewhat higher degree of accuracy.

In the case of Sputnik I, the orbital period and the day were almost, but not quite, commensurate. Successive passes day after day thus gradually precessed past the receiving station as shown in Fig. 3. If the *apparent* slant ranges (based on the assumption of straight line motion, as described above) are plotted as a function of time and two smooth curves are passed through the two sets of points, the result will be as shown in Fig. 4. The minima of these curves correspond to passes directly overhead and give the *apparent* heights.

The principal error that the simplified analysis has introduced arises from neglecting the curvature of the orbit. If a circular orbit at true height h is assumed, it is easy to show that for an overhead pass

$$\ddot{r}(0) = \frac{v^2}{r_0} \left(\frac{R}{R+h} \right)$$

where R is the radius of the earth. Comparing this equation with (3a) shows that the apparent height, h_a , obtained by plotting the slant ranges, is related to the true height h by

$$h = h_a \frac{R}{R+h}$$

or

$$h = \frac{2h_a}{1 + \sqrt{1 + 4 \frac{h_a}{R}}}$$

The elements of an orbit can be obtained by these methods with sufficient accuracy to anticipate visual passes and to follow the orbital history of the satellite. Naturally, more sophisticated computations can be made which will yield more accurate results for optical camera or radar tracking, but their complexity will also be considerably greater.

Appreciation is expressed to the staff of the Special Techniques Group of the Radio Systems Laboratory at SRI for valuable discussion of the foregoing methods.

—Peter D. Lacy and Kenneth E. Miller

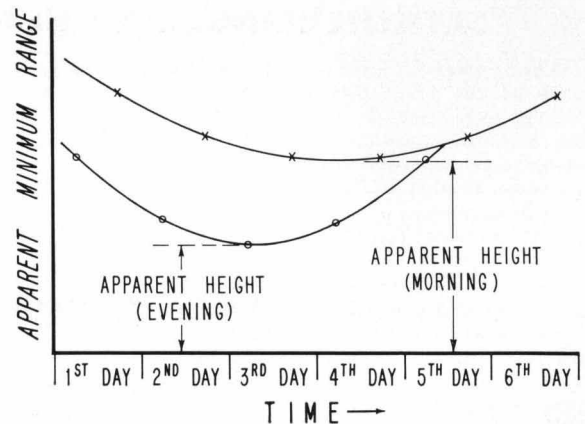

Fig. 4. Typical plot of apparent range heights as satellite precesses past receiving station.

WAVEGUIDE LOSS MEASUREMENTS

(Cont'd from p. 4)

ACCURACY

An analysis of the errors in the foregoing techniques indicates that the measurements are accurate within 10% db-wise. Further, measurements using the technique with different types of irises give results that are within 5% of each other.

RAPID SWEEP MEASUREMENTS FOR PRODUCTION WORK

In production work it is often desirable to be able to make routine checks that losses in manufactured devices do not exceed some established limit. Such checks can be made very rapidly by using an adaptation of the foregoing method that permits examination of losses on a swept basis with oscilloscope display.

The method consists of using the swept output of the Model 686A sweep oscil-

lator to cover the band of interest while observing the transmission characteristic on the oscilloscope. Fig. 6 shows the type of oscilloscope display typically obtained. Each of the peaks in Fig. 6 is a measure of the transmission at a frequency at which the test piece is resonant.

A go-no go calibration for swept operation can be obtained by displaying the transmission of a minimum-performance test piece whose loss has been measured using the basic procedure. The envelope of the responses can then be marked on the oscilloscope and used as a limit. This method has unusual sensitivity to changes in the measured loss, since at any one frequency a given percentage change in the resonance amplitude displayed on the oscilloscope face will be roughly equal to half the percentage db change in loss causing the resonance amplitude change.